

COPYRIGHT
 This drawing is protected by copyright and must not be reproduced in any form, including manufacture of the product shown therein, without the prior written consent of the copyright owners.
INDUSTRIAL PENSTOCKS LIMITED

DO NOT SCALE - IF IN DOUBT, ASK.

CUSTOMER : -
 SCHEME : -
 ITEM REFERENCE : -
 LOCATION : TBA
 QUANTITY : 1

MATERIAL SPECIFICATION

FRAME + DOOR DUCTILE IRON
 SEALING FACES PHOSPHOR BRONZE
 HINGE PINS STAINLESS STEEL
 HINGE LINKS PHOSPHOR BRONZE
 COATING BLACK EPOXY 150 MICRONS NOMINAL

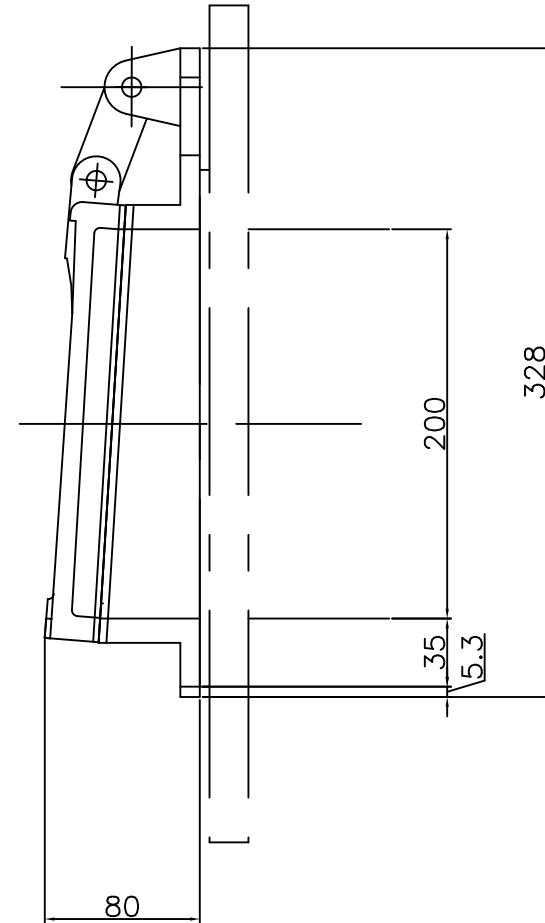
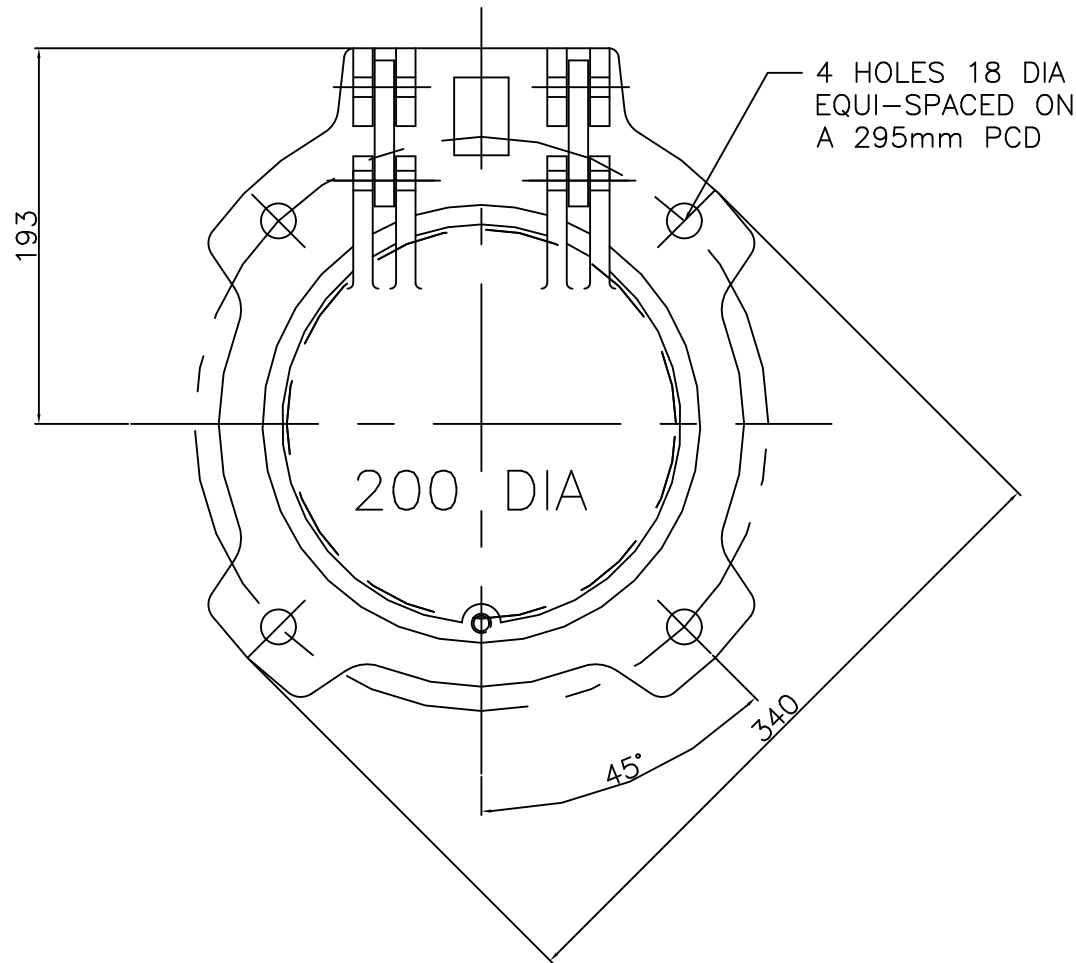

REVISION				REVISION				REVISION			
No	WAS	DATE	SIGN	No	WAS	DATE	SIGN	No	WAS	DATE	SIGN
/	/	/	/	/	/	/	/	/	/	/	/
/	/	/	/	/	/	/	/	/	/	/	/
/	/	/	/	/	/	/	/	/	/	/	/
/	/	/	/	/	/	/	/	/	/	/	/

200 DIA BORE
 CAST IRON
 WALL / PIPE MOUNTED
 FLAP VALVE

DRAWN	INDUSTRIAL PENSTOCKS LTD.	
A.J.S.	PENSTOCKS AND VALVES FOR THE WATER INDUSTRY	
DATE	UNITS 1 AND 2, WASHINGTON INDUSTRIAL ESTATE, WASHINGTON STREET, NETHERTON, DUDLEY. DY2 9PH	
12-05-06	TEL : 01384 488 411 FAX : 01384 246 950	
SCALE	PART No.	
NTS	DRAWING NUMBER	REV. 0
MATERIAL	200-GA	
AS QUOTED	FIRST USED ON ORDER REF.	V012778